

BLENDY BEZ ZAGŁĘBIENIA LICUJĄCE

Dragon Nemo	Cena netto [zł]			
	R1 (RL15) szer. 15 mm bez wywinięcia	R2 (RL30) szer. 30 mm wywinięcie 9 mm	R3 (RL70) szer. 70 mm wywinięcie 9 mm	R4 (RL100) szer. 100 mm wywinięcie 28 mm
2	180	180	290	300
2 XL	210	210	320	330
2 B	310	310	480	500
2 BXL	340	340	510	530
4	190	190	330	340
4 B	350	350	540	560
4 XL	200	200	350	360
4 BXL	370	370	570	590
6	190	190	330	340
6 XL	200	200	350	360
6 XXL	250	250	450	460
8	160	160	270	280
8 B	300	300	460	480
8 XXL	180	180	290	300
8 BXXL	340	340	500	520
9	240	240	380	390



R1 (RL15)



R2 (RL30)



R3 (RL70)



R4 (RL100)

BLENDY DO ZAGŁĘBIENIA 45 MM

Umożliwiają montaż dolnej kratki typu luft w dowolnym miejscu pod fasadą kominka

Dragon Nemo	Cena netto [zł]			
	R5 (RZ 9) szer. 9 mm bez wywinięcia, na blat	R6 (RZ 30) szer. 30 mm wywinięcie 9 mm	R7 (RZ70) szer. 70 mm wywinięcie 9 mm	R8 (RZ15) szer. 15 mm bez wywinięcia, kąt 45°
2	-	250	360	290
2XL	-	280	390	320
2B	400	380	550	420
2BXL	430	410	580	450
4	-	270	410	320
4B	460	430	620	480
4XL	-	280	430	340
4BXL	490	450	650	510
6	-	260	400	300
6XL	-	270	420	310
6XXL	-	330	530	380
8	-	220	330	260
8B	380	360	520	400
8XXL	-	250	360	300
8BXXL	420	410	570	450
9	-	310	450	350



R5 (RZ9)



R6 (RZ30)

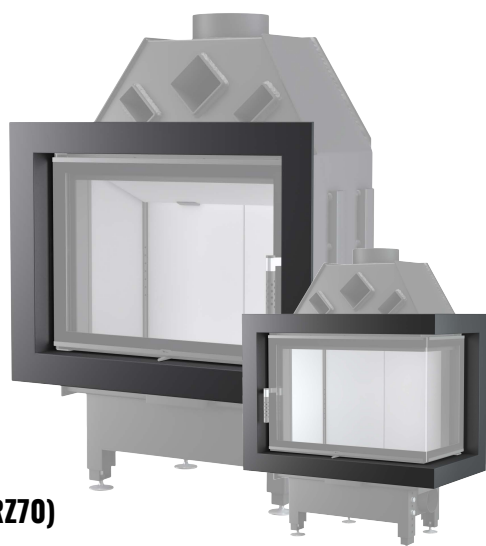

R7 (RZ70)

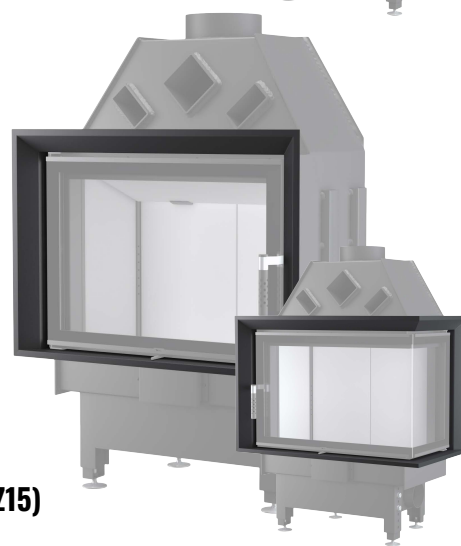

R8 (RZ15)

BLENDA LIFT - DO WKŁADÓW Z SYSTEMEM PODNOSZENIA PowerLIFT

Dragon Nemo	Cena netto [zł]			
	RL2 (GRL30) szer.30 mm wywinięcie 9 mm	RL5 (GRL9) szer.9 mm bez wywinięcia	RL7 (GRL70) szer.70 mm wywinięcie 9 mm	RL9 (GRL5) szer.5 mm bez wywinięcia
2	210	280	320	550
2XL	240	310	350	580
2B	350	410	510	590
2BXL	380	440	540	620
4	220	300	370	580
4B	380	470	570	620
4XL	230	310	380	600
4BXL	400	500	590	640
6	210	290	360	550
6XL	230	300	380	580
6XXL	290	360	490	620
8	200	250	310	450
8B	350	400	490	530
8XXL	230	280	330	480
8BXXL	360	440	520	560
9	260	340	410	600



RL2 (GRL30)



RL5 (GRL9)



RL7 (GRL70)



RL9 (GRL5)

Blendy w kolorze czarnym. Blendy inox na zamówienie, dopłata +60% do ceny netto.

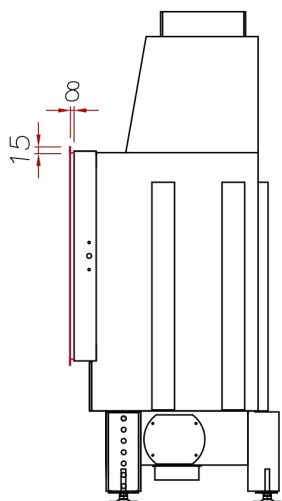

R1 (RL15)

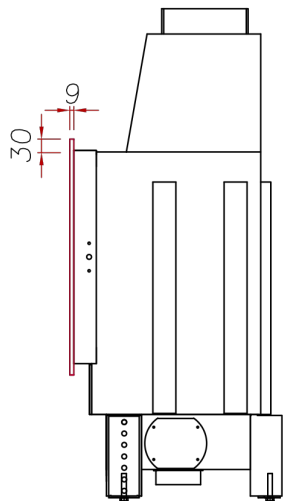

R2 (RL30)

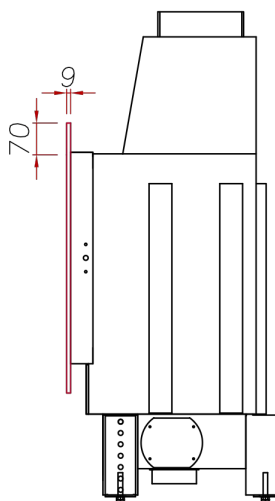

R3 (RL70)

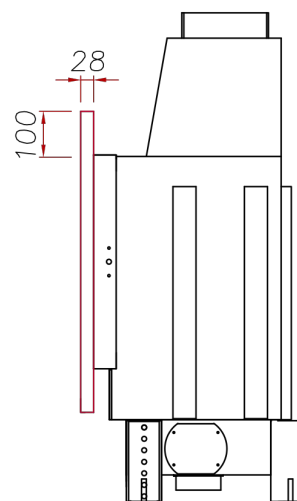

R4 (RL100)

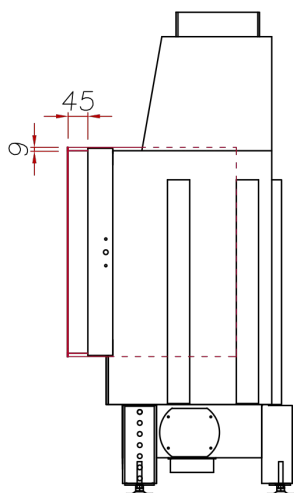

R5 (RZ9)

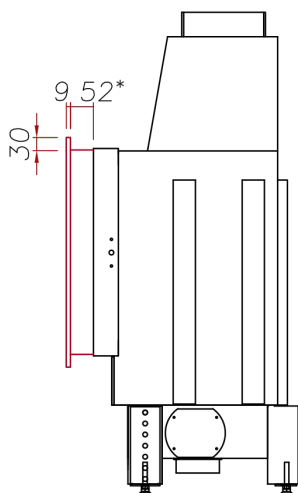

R6 (RZ30)

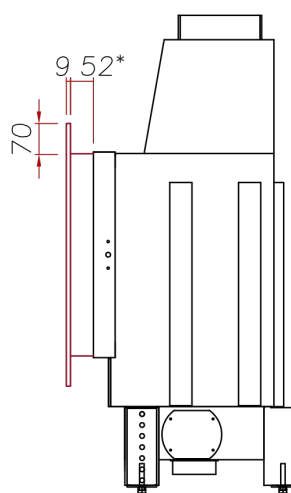

R7 (RZ70)

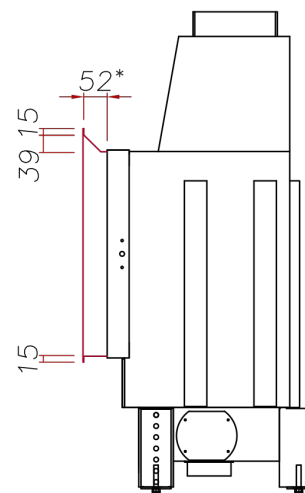

R8 (RZ15)

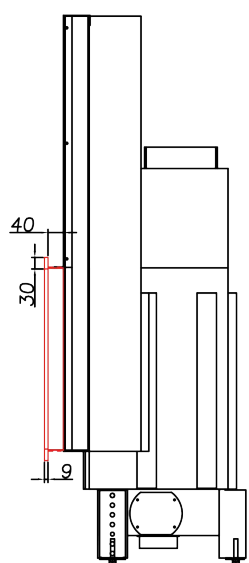

RL2 (GRL30)

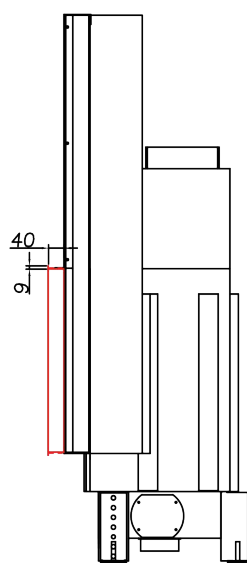

RL5 (GRL9)

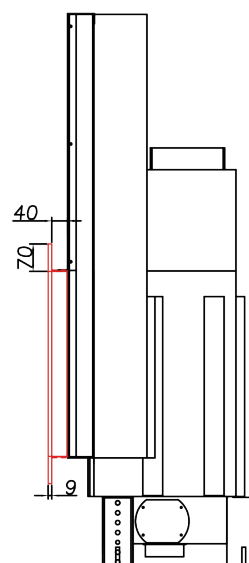

RL7 (GRL70)

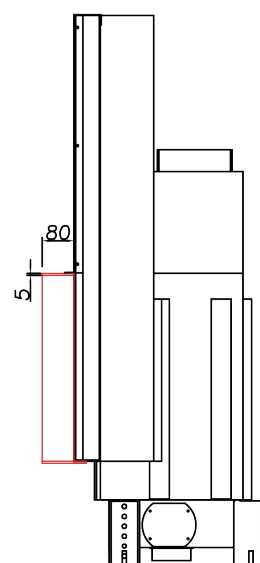

RL9 (GRL5)

* Zagłębienie 52 mm do wkładów prostych, 45 mm do wkładów narożnych